

Series 4300

Fabric Casement Window Awning with Support Arms



Series 4300 with Support Arms

It is our recommendation that you read instructions carefully prior to assembly and installation.

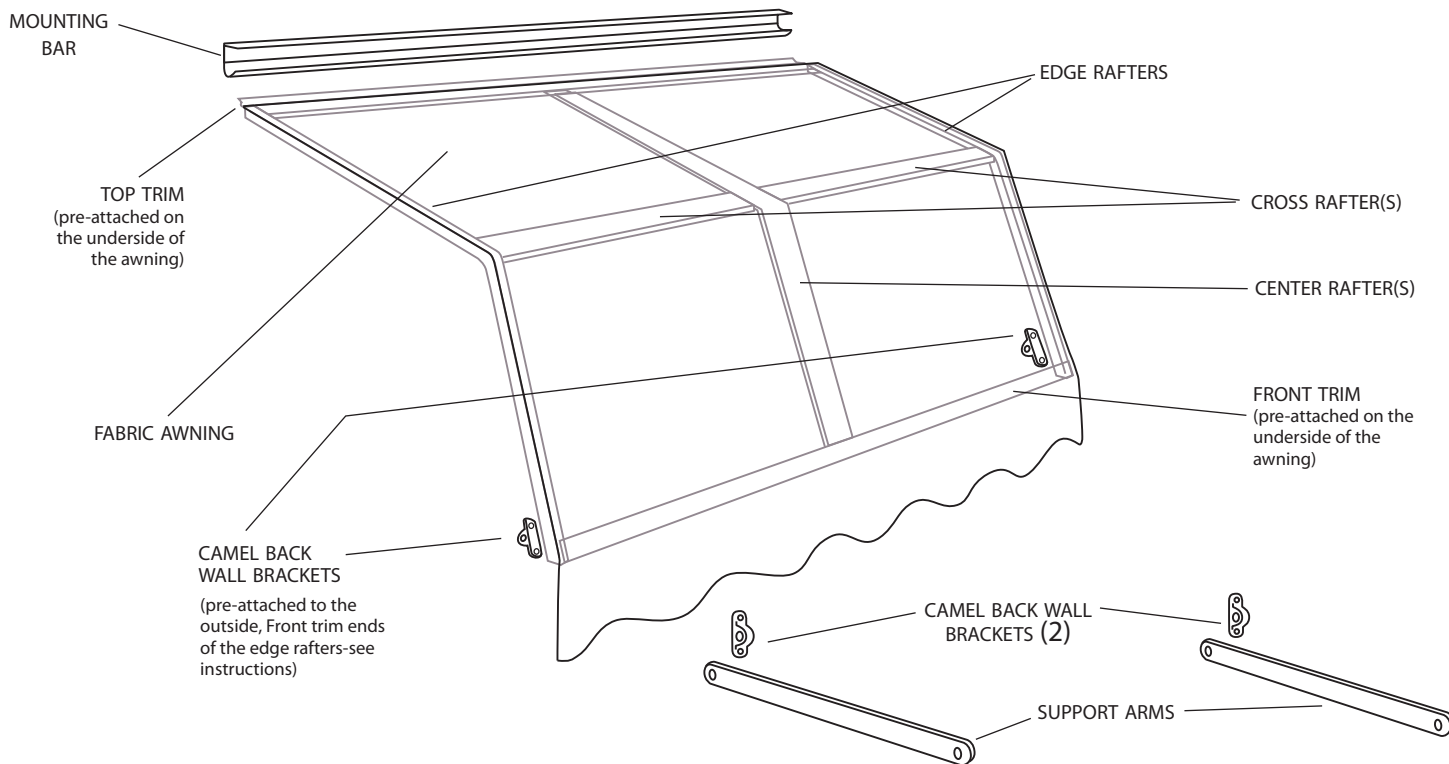

Series 4300 Parts Check List:

- | | | | |
|--|--|--|---|
| <input type="checkbox"/> Fabric Awning | <input type="checkbox"/> Edge Rafters (2) | <input type="checkbox"/> Cross Rafters* | <input type="checkbox"/> Small Screws* |
| <input type="checkbox"/> Top Trim (attached) | <input type="checkbox"/> Center Rafter(s)* | <input type="checkbox"/> Camel Back Wall Brackets* | <input type="checkbox"/> Large Screws* |
| <input type="checkbox"/> Front Trim (attached) | <input type="checkbox"/> Mounting Bar | <input type="checkbox"/> Support arms* | <input type="checkbox"/> Machine Screws (its tip is flat) |

*QUANTITIES INCREASE AS AWNING SIZES INCREASE. PLEASE SEE BACK PAGE FOR ADDITIONAL NOTES REGARDING AWNING SIZES.

Actual Size - End Views of Awning parts for easy reference and assembly:

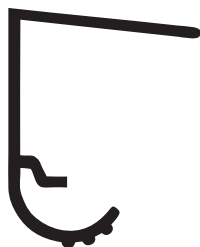

Mounting Bar



Top Trim



Front Trim



Edge & Center Rafter

Required Tools:

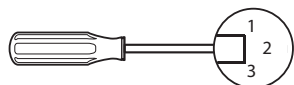

Phillips, Regular & 1/4" Hex Head Screwdrivers or Drill Bits

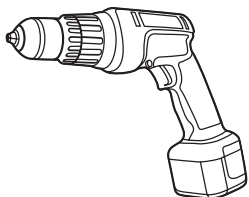

Power Drill

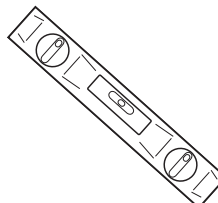

Level

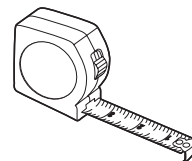

Tape Measure

Assembly Instructions

Series 4300 Fabric Window Awning

1



FIG. 1

Series 4300 Fabric Casement Window Awning comes packaged in two separate plastic bags (FIG. 1): Bag one contains the hardware and instructions; bag two contains the awning with three frame pieces, a Mounting Bar, Top Trim and Front Trim. For your convenience, the Front Trim and Top Trim frame parts are already attached to the awning.

2

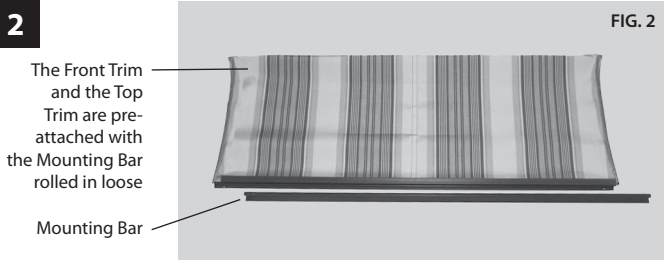

FIG. 2

The awning will come rolled with the top or outside rolled to the inside. Unroll the awning and flip the entire awning over. (The Mounting Bar is rolled inside the awning and will be used in Step 1 of this manual's *Installation Instructions*. Set it aside for now.) The awning will be assembled from this position, **upside (or topside) down** and **inside (or underside) up**. The Top Trim and Front Trim frame pieces are already attached.

3

Attach one end of each of the Support Arms to each Edge Rafter by inserting it into the Camel Back Wall Bracket (already attached) using machine screws.

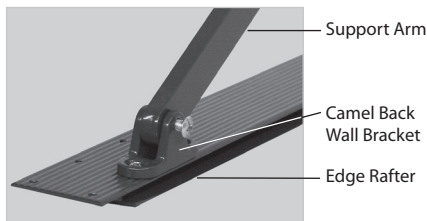

FIG. 3

*NOTE: Insert the machine screws through the Camel Back Wall Bracket and Support Arms (FIG. 3) **from the outside in**, toward the awning.*

4

Attach each Edge Rafter to the Front Trim using small screws in pre-punched holes.

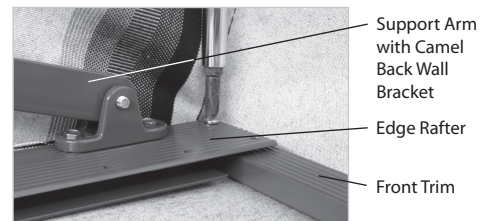
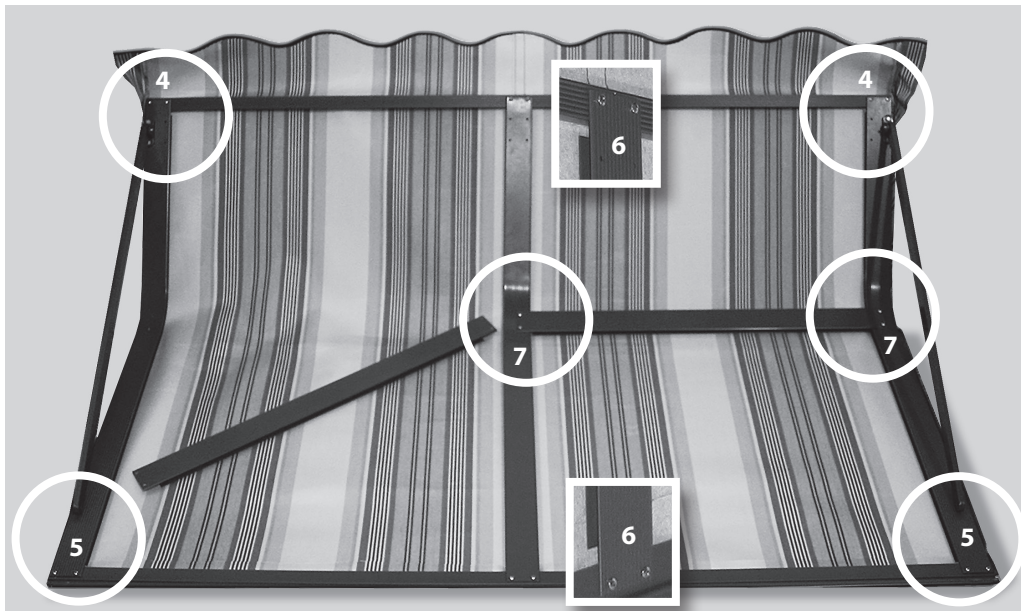

FIG. 4

NOTE: Be sure to position the Edge Rafters so that the end with the attached Camel Back Wall Bracket/Support Arm is toward the outside of the awning. This way, the end of the screw is toward the inside and will not wear on the fabric.



5

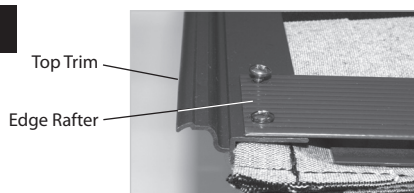

FIG. 5

Attach the other end of the Edge Rafter to the Top Trim (FIG. 5) using two small screws in pre-punched holes.

6

Awnings 47" wide and over require a Center Rafter: Attach Center Rafter to the Front Trim and to the Top Trim using two small screws in pre-punched holes.

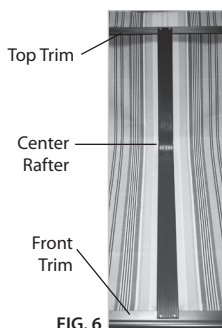

FIG. 6

7

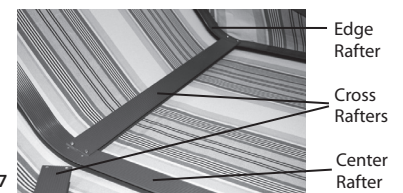

FIG. 7

Attach Cross Rafter(s) from Edge Rafter(s) to Center Rafter(s) and from Center Rafter(s) to Edge Rafter(s) (FIG. 7) using two small screws in pre-punched holes. (Awnings 46" wide and under have a 1-piece Cross Rafter.)

Turn your awning top side up. It is now ready for installation.



SERIES 4300
with Support Arms

Installation Instructions

1

Caulk
Mounting Bar
6-inch clearance
Wall
Mounting Bar

FIG. 1

< INSET: Position the Mounting Bar against the wall as shown here.

Install Mounting Bar with large screws 6" above the window. Windows opening more than 18" will require additional mounting space.

Be sure the bar is level and centered over the window opening. Screws must be in studs or heavy sheathing. (Drill alternate holes in bar if necessary.)

Please refer to FIG. 1 INSET to place the Mounting Bar correctly on the wall.

! *Caulk the top of the mounting bar against the house.*

2

Lift the front of the awning upward and insert the Top Trim into the Mounting Bar (FIG. 2A). Lower the front of the awning slowly and allow Support Arms to rest on the house (FIG. 2B); be sure the two parts are completely interlocked. Align holes and secure Top Trim to Mounting Bar with small screws from bottom side (FIG. 2C).

FIG. 2A

insert

lift awning upward

interlocked

lower front of awning slowly

awning side

camel back wall bracket

support arm

FIG. 2B

FIG. 2C

small screw

3

Mounting Bar

Mount Camel Back wall Brackets plumb and in line with the Mounting Bar

A

Mounting Brackets

A

Temporarily attach the two loose Camel Back Wall Brackets to the other end of the Support Arms using machine screws.

Before securing Support Arms with Camel Back Wall Brackets to your house, please refer to the mounting chart on the left for model number and correct mounting points for your awning.

Now attach Mounting Brackets to the house using large screws, making sure the Camel Back Wall Brackets are secured in solid sheathing at the proper points from the reference chart.

NOTE:
Mounting dimension "A" is measured from the top of the Mounting Bar to the center of the Mounting Bracket (see chart).

Fabric Casement Window Awning Mounting Chart				
Model Number	6	7	8	9
Mounting Point	17-1/2"	24"	29-1/4"	33-3/4"

All mounting points are approximate.

Thank you for ordering the Series 4300 Fabric Casement Window Awning

Nulmage Awnings® has a full line of fabric awnings to complement your selection. Contact your local home improvement retailer, or visit www.nuimageawnings.com today to learn more about these other quality products made in the USA.

Series 2700



Fabric Door Canopy

Series 3300



Fabric Window Awning
with Support Arms

Series 5700



Fabric Roll-up
Window Awning

NUShade



Retractable Patio Awning

Limited Warranty information

Nulmage® Awnings and Canopies are manufactured by Futureguard® under the highest standards of production, after comprehensive research and development, and will be warranted by Futureguard® to the original purchaser from date of purchase for a period of Five (5) years against the occurrence of manufacturing defects directly resulting in peeling, flaking, blistering or rusting under conditions of normal use and service, subject to the terms and conditions contained in this Limited Warranty.

Futureguard® does not warrant installation nor defects caused by installation. This Limited Warranty does not cover any other defects as specified herein. This Limited Warranty does not cover any other damage or material failure resulting from, but not limited to, normal weathering, oxidation, accidental damage or intentional damage, fire or flood, windblown objects, windstorm, sleet or chemical pollutants, mildew or structural defects, negligent maintenance or misuse or abuse, or any other causes or occurrences beyond the control of Futureguard®. Under this warranty Futureguard agrees to provide material, repair, refinish, or replace at their sole option, only the parts found to be defective at no cost to the original owner. This warranty does not include any shipping or labor required to complete the warranty work.

Normal weathering may cause any surface to oxidize, chalk, gradually fade or accumulate surface dirt or stains due to varying exposures to sunlight, weather or atmospheric conditions. The geographic location, the quality of the atmosphere and other local factors in the area, over which Futureguard® has no control, contribute to the severity of these conditions.

This Limited Warranty is void if incompatible accessory products are installed which cause defects to occur.

The provisions of this Limited Warranty are the full and complete warranty policy extended by Futureguard®.

This Limited Warranty shall be null and void if harmful cleaning compounds are used.

THE WARRANTY STATEMENTS CONTAINED IN THIS LIMITED WARRANTY SET FORTH THE ONLY EXPRESS WARRANTIES EXTENDED BY FUTUREGUARD®, IN LIEU OF ALL OTHER WARRANTIES, AND THE PROVISIONS OF THIS LIMITED WARRANTY SHALL CONSTITUTE THE ENTIRE LIABILITY OF FUTUREGUARD® AND THE PROPERTY OWNER'S EXCLUSIVE REMEDY FOR BREACH OF THIS WARRANTY FUTUREGUARD® SHALL NOT BE LIABLE TO THE PROPERTY OWNER FOR INCIDENTAL OR CONSEQUENTIAL DAMAGES OF ANY KIND FOR BREACH OF ANY EXPRESS OR IMPLIED WARRANTY.

Claim procedure and other warranty provisions. All claims for warranty must be reported in writing to Futureguard, 101 Merrow Road, Auburn, Maine 04210 Attention: Warranty Dept., within the warranty period and promptly after discovery. Describe the defect in detail and include photos, if possible together with proof of purchase. The effective warranty date shall not be increased by any such warranty work performed and the remaining warranty time shall continue in effect.

Some states do not allow the exclusion or limitation of incidental or consequential damages, so the above limitations or exclusions may not apply to you. This Warranty gives you the specific legal rights and you may also have other rights, which vary from state to state.



www.nuimageawnings.com

Customer Service 1-800-901-3313



FGNI.4300.Rev12/16