

Series 4500 Aluminum Casement Window Awning with Sidewings

It is our recommendation that you read instructions carefully prior to assembly and installation.

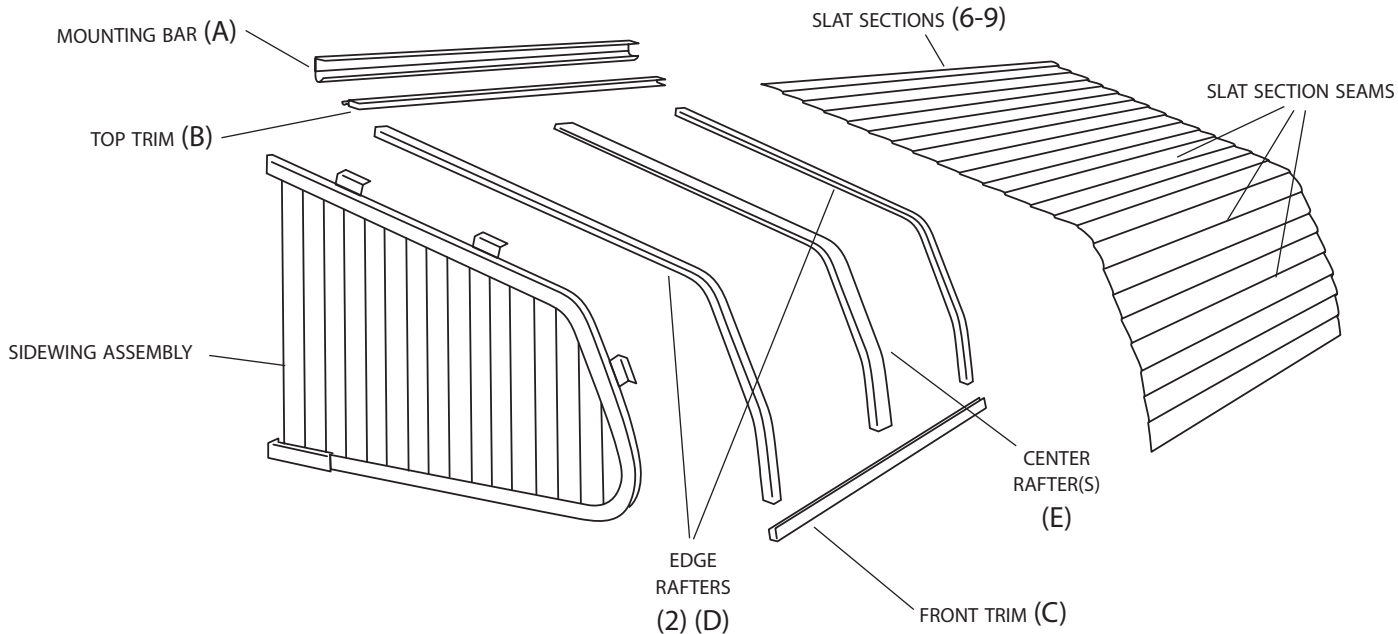

Series 4500 with Sidewings



Series 4500 Parts Check List:

- | | | | |
|---------------------------------------|--|--|--|
| <input type="checkbox"/> Mounting Bar | <input type="checkbox"/> Edge Rafters (2) | <input type="checkbox"/> Sidewings | <input type="checkbox"/> Small Screws* |
| <input type="checkbox"/> Top Trim | <input type="checkbox"/> Center Rafter(s)* | <input type="checkbox"/> Interlock Clips* | <input type="checkbox"/> Large Screws* |
| <input type="checkbox"/> Front Trim | <input type="checkbox"/> Slat Section Assembly | *QUANTITIES & SIZE OF PARTS MAY VARY BY AWNING SIZE AND MODEL SERIES | |

Actual Size End Views of Awning parts for easy reference and assembly:



Mounting Bar (A)



Top Trim (B)



Front Trim (C)



Edge Rafter (D)



Center Rafter (E)

Required Tools:

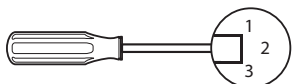

Phillips, Regular & 1/4" Hex Head
Screwdrivers or Drill Bits

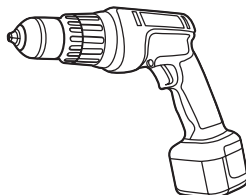

Power Drill

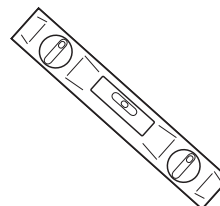

Level

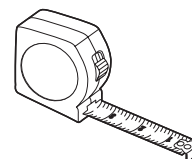

Tape Measure

1

Slats have a slight curve to them. Keep them this way for assembly.

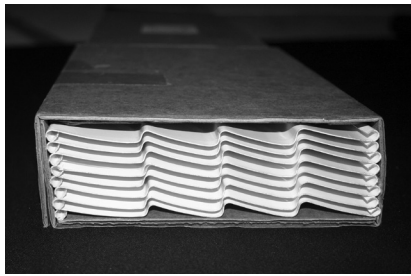

FIG. 1A

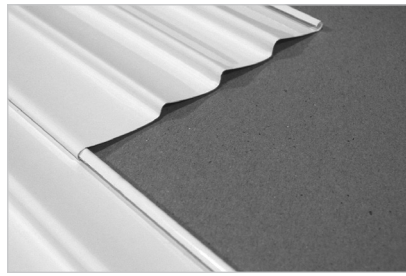

FIG. 1B

The awning is assembled upside down. Note that the Slat Sections are packaged upside down (FIG. 1A). Assemble on a flat surface.

CAUTION: Awning parts may have sharp edges. Use care in assembly.

Lay the first slat out, curled edge **DOWN** on your left with ends toward you. Slide each subsequent slat into the curled **UP** edge on the right (FIG. 1B).

2



FIG. 2

While keeping Slat Sections **flush with each other**, crimp slats together at each seam interlock with a pair of channel lock pliers about 1/4 inch in from the edge (not too much — only enough to secure them together). Be sure to keep the plier teeth level with slats so that you do not accidentally bend them up while crimping.

3

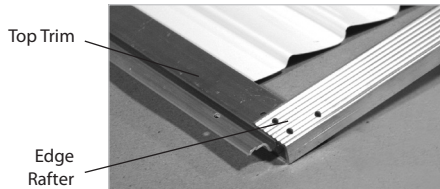

FIG. 3

TIP: Use the palm of your hand flat on slats, pressing down and pulling toward you to help snug them into Edge Rafter.

Slide the Top Trim out from Slat Section about 2 inches to provide clearance. Next, slide the non-curved end of the Edge Rafter onto Top Trim, making sure the opposite, curved end, of the Edge Rafter is up.

Next, slide both Top Trim and Edge Rafter back toward Slat Section and push Edge Rafter onto Slat Section edge evenly until Slat Section and Top Trim are completely **FLUSH** into Edge Rafter.

4

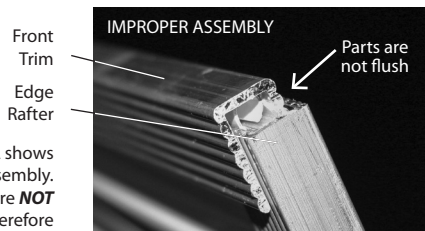

FIG. 4A

FIG. 4A shows improper assembly. These parts are **NOT** flush and therefore will not align to fasten screws



FIG. 4B

NOTE: It is very important that both ends of the awning (the top trim and the front trim) along with the slat section are **completely flush** in the edge rafters to be able to align pre-punched holes for fastening. See FIG. 4B.

Now, connect the Edge Rafter and Slat Section with the Front Trim. Again, Slat Section and Front Trim **MUST** be **FLUSH** in the Edge Rafter. With Slat Section still secured **FLUSH** in Edge Rafter, slide Front Trim toward you and flush into the Edge Rafter, aligning pre-punched holes; it will fit snug.

NOTE: Only the outside edge of the Front Trim and the curled edge of the slat are inserted into the Edge Rafter (FIG. 4B).

Next, secure Top Trim and Front Trim with small screws in the larger pre-punched holes at **each end** of the Edge Rafter.

5

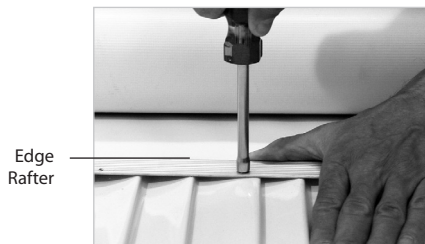

FIG. 5

Next, fasten small screws in the two larger pre-punched holes along Edge Rafter. (Pairs of small holes are for Sidewings.)

NOTE: Support the underside of the Slats Section and apply pressure while fastening screws.

Repeat Steps 3, 4, and 5 for Edge Rafter assembly on the other side of the awning.

6

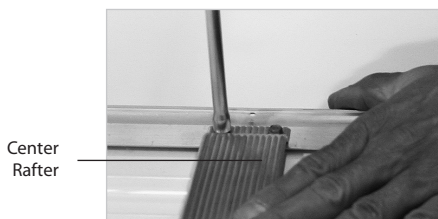

FIG. 6

Now attach Center Rafter. Align Center Rafter with pre-punched holes in the center of the Top Trim first and secure with small screws, then do the same at the other end of the Center Rafter in the center on the Front Trim and secure with small screws.

NOTE: Window Awnings wider than 60" need more than one Center Rafter, which will be provided. Pre-punched holes will guide installation of multiple Center Rafters.

7Interlock
Clip

FIG. 7

Next, install Interlock Clips to secure frame to Awning: Connect Awning Slat Section Assembly to the Center Rafter frame using Interlock Clips at each joint where the slats interlock. Installing clips is a three-step process: (1) Find the slot joint; (2) Insert the curved part of clip into slot joint; (3) Slide clip onto Center Rafter. Interlock Clips are installed on the flat section of the awning only, not up on the curve. If stubborn, make sure they are straight and parallel with the slat joint.

8Small Screws
Edge Rafter
Connector

FIG. 8A

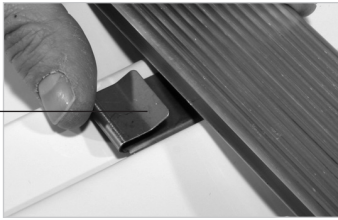

FIG. 8B

Attach Sidewings to Edge Rafters with small screws using pre-drilled holes (FIG. 8A). You will need to use a 1/4" hex head screwdriver (FIG. 8B).

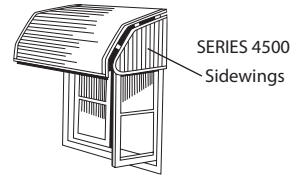

Installation Instructions

1Caulk
Mounting Bar
Window
Frame
Mounting Bar

FIG. 1

Install Mounting Bar and secure with large screws on the window frame or in strong sheathing on the house around the window (if you measured for placement of your awning on the *outside* of the window frame). In this case, install the Mounting Bar on the house above the window frame.

Be sure the Mounting Bar is level and centered over the opening.

! *Caulk the top of the Mounting Bar against the house.*

2

Lift the front of the awning upward and insert the Top Trim into the Mounting Bar (FIG. 2A). Lower the front of the awning slowly and allow Sidewings to rest on the house (FIG. 2B); be sure the two parts are completely interlocked. Align holes and secure Top Trim to Mounting Bar with small screws from bottom side (FIG. 2C).

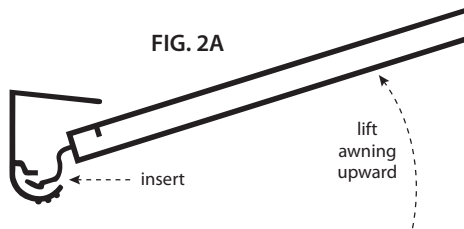

FIG. 2A

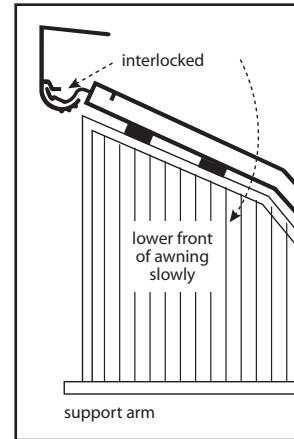

FIG. 2B

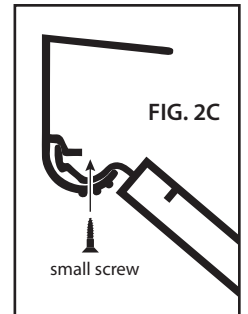

FIG. 2C

34500
Sidewing
Sidewing
Mounting
Bracket

FIG. 3

Adjust Sidewings so they are vertically plumb. Attach Sidewings to house with large screws.

Installation of door canopy with Sidewings is now complete.

Thank you for ordering the Series 4500 Aluminum Casement Window Awning

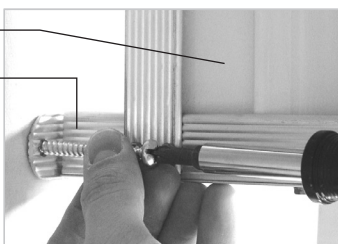
Nulmage Awnings® has a full line of aluminum awnings to complement your selection. Contact your local home improvement retailer, or visit www.nulmageawnings.com today to learn more about these other quality products made in the USA.

Series 1500



Aluminum Door Canopy
with Sidewings

Series 3500



Aluminum
Window Awning
with Sidewings

Series 5500



Aluminum Roll-up
Window Awning

NUShade



Retractable Patio Awning

Limited Warranty information

Nulmage® Awnings and Canopies are manufactured by Futureguard® under the highest standards of production, after comprehensive research and development, and will be warranted by Futureguard® to the original purchaser from date of purchase for a period of Five (5) years against the occurrence of manufacturing defects directly resulting in peeling, flaking, blistering or rusting under conditions of normal use and service, subject to the terms and conditions contained in this Limited Warranty.

Futureguard® does not warrant installation nor defects caused by installation. This Limited Warranty does not cover any other defects as specified herein. This Limited Warranty does not cover any other damage or material failure resulting from, but not limited to, normal weathering, oxidation, accidental damage or intentional damage, fire or flood, windblown objects, windstorm, sleet or chemical pollutants, mildew or structural defects, negligent maintenance or misuse or abuse, or any other causes or occurrences beyond the control of Futureguard®. Under this warranty Futureguard agrees to provide material, repair, refinish, or replace at their sole option, only the parts found to be defective at no cost to the original owner. This warranty does not include any shipping or labor required to complete the warranty work.

Normal weathering may cause any surface to oxidize, chalk, gradually fade or accumulate surface dirt or stains due to varying exposures to sunlight, weather or atmospheric conditions. The geographic location, the quality of the atmosphere and other local factors in the area, over which Futureguard® has no control, contribute to the severity of these conditions.

This Limited Warranty is void if incompatible accessory products are installed which cause defects to occur.

The provisions of this Limited Warranty are the full and complete warranty policy extended by Futureguard®.

This Limited Warranty shall be null and void if harmful cleaning compounds are used.

THE WARRANTY STATEMENTS CONTAINED IN THIS LIMITED WARRANTY SET FORTH THE ONLY EXPRESS WARRANTIES EXTENDED BY FUTUREGUARD®, IN LIEU OF ALL OTHER WARRANTIES, AND THE PROVISIONS OF THIS LIMITED WARRANTY SHALL CONSTITUTE THE ENTIRE LIABILITY OF FUTUREGUARD® AND THE PROPERTY OWNER'S EXCLUSIVE REMEDY FOR BREACH OF THIS WARRANTY FUTUREGUARD® SHALL NOT BE LIABLE TO THE PROPERTY OWNER FOR INCIDENTAL OR CONSEQUENTIAL DAMAGES OF ANY KIND FOR BREACH OF ANY EXPRESS OR IMPLIED WARRANTY.

Claim procedure and other warranty provisions. All claims for warranty must be reported in writing to Futureguard, 101 Merrow Road, Auburn, Maine 04210 Attention: Warranty Dept., within the warranty period and promptly after discovery. Describe the defect in detail and include photos, if possible together with proof of purchase. The effective warranty date shall not be increased by any such warranty work performed and the remaining warranty time shall continue in effect.

Some states do not allow the exclusion or limitation of incidental or consequential damages, so the above limitations or exclusions may not apply to you. This Warranty gives you the specific legal rights and you may also have other rights, which vary from state to state.



www.nulmageawnings.com

Customer Service 1-800-901-3313



FGNI.4500.Rev12/16